

This file contains scalable dynamic blocks for our 3750 Series Swing Door. Here is how to use them:

1. Select the desired panel configuration.
2. Highlight the block.
3. At the bottom, left of the block is a Visibility Grip. You left click the Grip. (see Figure A) You can select the desired Panel Configuration.
4. Both the Door Width & Height are similar. (see Figure B & C) Left click the Grip to change the Door's Width and/or Height. You can either enter the dimension or drag the grip to the desired Net Frame Width & Height.

**Please note that the dimensions reflect Net Frame Size NOT Rough Opening.**

Panel size is +/- 3/8". If panel size is critical, please refer to the factory.

This file can be saved in your Design Center.

Figure A

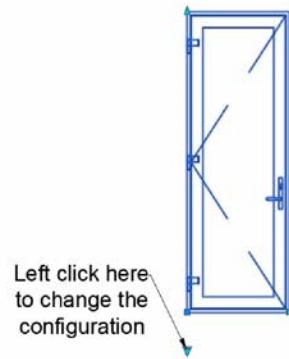

Figure B

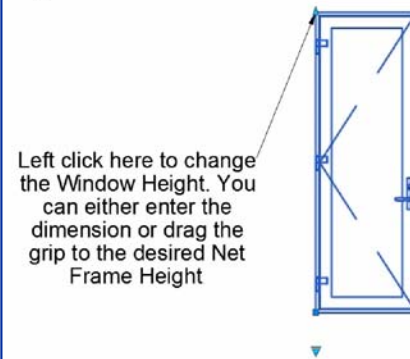
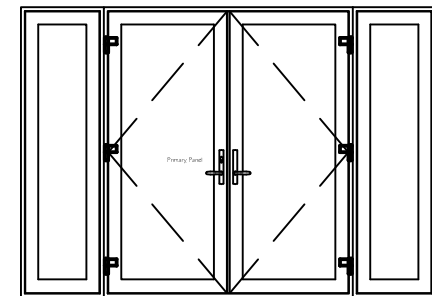
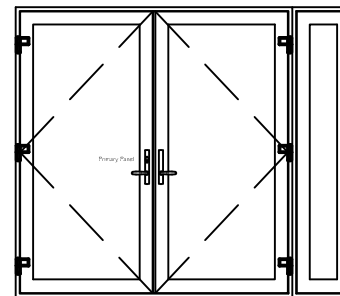
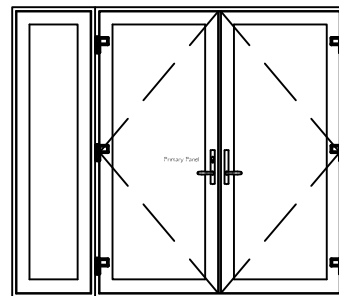
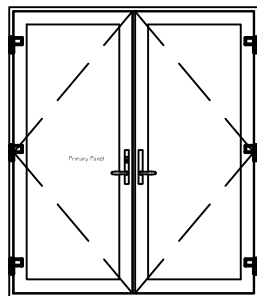
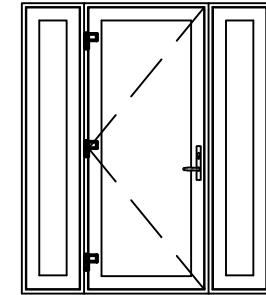
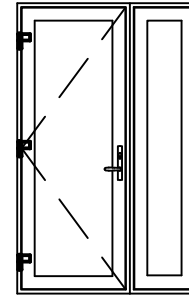
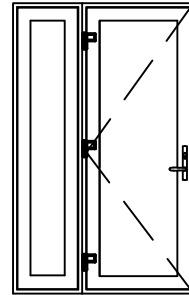
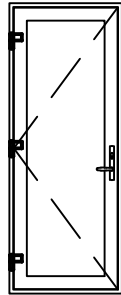
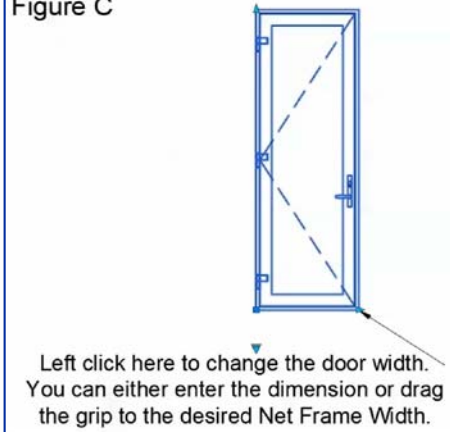

Figure C



Notice: This document contains information proprietary to and is protected by copyright of Win-Dor Inc. and shall not be copied, disclosed to others, or used for any purpose other than that for which it is given, without the written permission of Win-Dor Inc.

**WINDOR**  
www.windorsystems.com

450 Delta Ave  
Brea, Ca 92821  
(714) 385-1202

Project:

File name: 3750 Swing Door Elevation - Outswing Complete Series

Date: 20190906

Notes:

Layout: Complete Series

Drawn by: J Johnson